

Contact Details

Before using the product, please check the guide pages at the front of this catalog.

Internet

<http://www.daikinpmc.com/en/>

For latest information, PDF catalogs and operation manuals

Inverter Controlled Water Chiller AKW**9



Features

- **Enhancement of highly accurate temperature control**
 - The oil temperature is controlled within $\pm 0.1^{\circ}\text{C}$ under a wider operation range than the previous model as an optional function.
- **Extension of cooling capacity control range**
 - Control with loads from 0 % (no load) to 100 % achieved
- **Complies with RoHS Directives such as Lead-Free**
- **Environment friendly unit, countering global warming**
 - Adopts a Daikin original IPM motor which is a super-energy-efficient technology
- **Achieves 30% energy savings compared to the AKW 8 series (measured by Daikin)**
 - Adopts R410A refrigerant which does not contribute to ozone depletion
- **Low noise level for a better working environment**
 - Achieves a lower noise level than the AKW 8 series

AKW8	AKW9 Series
65 dB (A)	60 dB (A) AKW149/189
	61 dB (A) AKW329/359
	62 dB (A) AKW439/459

Nomenclature

AKW ** 9 - ** **

1 2 3 4

1 Standard type

AKW: High-accuracy inverter controlled oil cooling unit
[Circulating type, for clean fresh water (tap water)]

2 Cooling capacity (kW)

14: 1.4 kW 56: 5.6 kW
18: 1.8 kW 90: 9.0 kW
32: 3.2 kW
35: 3.5 kW
43: 4.3 kW
45: 4.5 kW

3 Symbol of series

(Symbol to represent model change)
9: "9" series

4 Symbol of option type (C/H)/Non-standard number

Options and their combinations

■ AKW149-189-329-359-439-459

Symbol of option type	With breaker	Compliance with CE
-B	✓	-
-C	-	✓
-BC	✓	✓

■ AKW569-909

Symbol of option type	With breaker	Compliance with CE	With heater	Different voltage type (1)	Different voltage type (2)	Different voltage type (3)
-B	✓	-	-	-	-	-
-C	-	✓	-	-	-	-
-H	-	-	✓	-	-	-
-046	-	-	-	✓	-	-
-047	-	-	-	-	✓	-
-048	-	-	-	-	-	✓
-BC	✓	✓	-	-	-	-
-BH	✓	-	✓	-	-	-
-CH	-	✓	✓	-	-	-
-BCH	✓	✓	✓	-	-	-
-001	✓	-	-	✓	-	-
-002	-	✓	-	✓	-	-
-003	-	-	✓	✓	-	-
-005	✓	✓	-	✓	-	-
-006	✓	-	✓	✓	-	-
-008	-	✓	✓	✓	-	-
-011	✓	✓	✓	✓	-	-
-017	✓	✓	-	-	✓	-
-018	✓	-	✓	-	✓	-
-023	✓	✓	✓	-	✓	-
-032	✓	✓	-	-	-	✓
-033	✓	-	✓	-	-	✓
-038	✓	✓	✓	-	-	✓

Different voltage type (1) With transformer AC 220, 230 V 50/60 Hz
 Different voltage type (2) With transformer AC 380, 400, 415 V 50/60 Hz
 Different voltage type (3) With transformer AC 440, 460, 480 V 50/60 Hz

Applications

- Semiconductor production equipment, Laser cutting machines/Laser oscillators, Electrical discharge machines/Beam welding machines, Various analyzing apparatus/ Medical equipment, etc.

Specifications

		With pump/tank			Without pump/tank			With pump/tank		
Equivalent horsepower of chiller HP		0.5	1.2	1.5	0.5	1.2	1.5	2.0	3.0	
Model name		AKW149	AKW329	AKW439	AKW189	AKW359	AKW459	AKW569	AKW909	
Cooling capacity (50/60 Hz) *1 kW		1.4/1.4	3.2/3.2	4.3/4.3	1.8/1.8	3.5/3.5	4.5/4.5	5.6/5.6	9.0/9.0	
Power supply *2		Three-phase AC 200/200·220 V 50/60 Hz								
Power voltage	Main circuit	Three-phase AC 200/200·220 V 50/60 Hz								
	Operation circuit	DC 12/24 V								
Max. power consumption Max. current consumption	200 V 50 Hz	1.20 kW/4.5 A	1.71 kW/6.4 A	1.97 kW/7.4 A	0.79 kW/3.2 A	1.29 kW/5.2 A	1.59 kW/6.1 A	2.64 kW/8.5 A	4.81 kW/15.5 A	
	200 V 60 Hz	1.36 kW/4.8 A	1.87 kW/6.6 A	2.20 kW/7.8 A	0.79 kW/3.2 A	1.29 kW/5.0 A	1.61 kW/6.0 A	2.78 kW/9.0 A	4.89 kW/15.3 A	
	220 V 60 Hz	1.36 kW/4.8 A	1.87 kW/6.6 A	2.20 kW/7.8 A	0.79 kW/3.0 A	1.29 kW/4.7 A	1.61 kW/5.4 A	2.84 kW/8.4 A	5.03 kW/14.6 A	
External paint color		Ivory white								
External dimensions (H × W × D) mm		690 × 360 × 700	815 × 360 × 700	915 × 360 × 700	650 × 360 × 440	775 × 360 × 440	875 × 360 × 440	1,197 × 470 × 500	1,309 × 560 × 620	
Compressor (Hermetic DC swing type)		Equivalent to 0.4 kW	Equivalent to 0.75 kW	Equivalent to 1.1 kW	Equivalent to 0.4 kW	Equivalent to 0.75 kW	Equivalent to 1.1 kW	Equivalent to 1.5 kW	Equivalent to 2.2 kW	
Evaporator		Brazen plate type								
Condenser		Cross-fin-coil type								
Propeller fan	Motor capacity W	54						100		
	Model	Immersion type multistage pump						Cascade pump		
Water pump	Head (50/60 Hz) *3	25/37 m at 10 L/min	24/36 m at 15 L/min			-		14/32 m at 30 L/min	12/36 m at 50 L/min	
	Motor capacity (50/60 Hz) kW	0.33/0.52						0.4	0.75	
Temperature control (Selectable)	Synchronization type	Standard	Room temperature or machine temperature *4 (Set to room temperature by default)							
		Controlled object	Water temperature in the tank			Outlet water temperature			Water temperature in tank, outlet water temperature	
		Synchronization range	-9.9 to +9.9K							
	Fixed type	Controlled object	Water temperature in the tank			Outlet water temperature			Water temperature in tank, outlet water temperature	
Range °C					10 to 40			5 to 45		
Refrigerant control		Rotation speed control of compressor by inverter + Opening rate control of electric expansion valve								
Refrigerant (R410A) Changed volume kg		0.49	0.72	0.98	0.49	0.72	0.98	1.02	1.48	
Protection devices		A set of overcurrent relay (for a pump motor, only for models with a pump), reverse-phase protection device, restart prevention timer, low room temperature protection thermostat, high fluid temperature protection thermostat, low fluid temperature protection thermostat, discharge pipe temperature thermostat, condenser temperature thermostat, refrigerant leakage detector, inverter protection device, high pressure switch (-C type only), compressor thermal protector (-C type only), intake pipe temperature thermostat (antifreeze), and circuit breaker (-B type only)								
Operation range	Room temperature °C	10 to 40 (*5: 5 to 40)						5 to 45		
	Water temperature in the tank °C	10 to 40 (*5: 5 to 40)						5 to 45		
	Outlet water temperature °C	-						10 to 40 (*5: 5 to 40)		
	Permissible circulating water volume *6 L/min	6 to 15	10 to 20	10 to 30	6 to 15	10 to 20	10 to 30	20 to 40	40 to 60	
	Rated circulating water volume L/min	10	15			10	15		30	50
	Acceptable fluid *7	Fresh water (tap water)								
Max. pressure in a MPa cooling water circuit		-			0.5			-		
External pressure loss (50/60 Hz)		0.24/0.36	0.21/0.34			-		0.14/0.31	0.11/0.35	
Connecting pipe size MPa		Refer to the outline drawing.								
Tank capacity L		10			-			15	20	
Noise level (Value equivalent to measurement in an anechoic chamber) dB (A) (Front 1 m, height 1 m)		60	61	62	60	61	62	65	67	
Permissible transport vibration		Up and down vibration 14.7 m/s ² (1.5G) × 2.5 hr (7.5 to 100 Hz sweep/5 min.)								
Mass kg		61	65	68	36	40	43	90	105	
Items prepared by the customer	Molded-case circuit breaker (Rated current) A				10			15	30	

L OIL COOLING EQUIPMENT

Note: *1 The cooling capacity indicates the value at the standard point. This unit has about ±5% of product tolerance.
 *2 Use a commercial power supply for the power source. The use of an inverter power supply may cause burn damage to the machine.
 *3 This unit has about ±7% of product tolerance.
 *4 The machine temperature synchronization thermistor available as an option is required for this function.
 *5 A unit that can be used at a room temperature of 5 to 40°C or a tank outlet water temperature of 5 to 40°C is available as an option. Please consult us for details.
 *6 Use the unit with a circulating water volume within the permissible range.
 *7 Use fluid that satisfies the water quality standard for clean fresh water (tap water) level indicated on Page L-32. (Taken from Guideline of Water Quality for Refrigeration and Air Conditioning Equipment (JRA-GL-02-1994).)

Contact Details

Before using the product, please check the guide pages at the front of this catalog.

Internet

<http://www.daikinpmc.com/en/>

For latest information, PDF catalogs and operation manuals

Operation range

Note: 1. The mark◎ shows the standard point.

2. Be sure to use the unit within the range of use specified in [].

(Use outside this range may cause unit failure.)

■ AKW149, 189, 329, 359, 439, 459

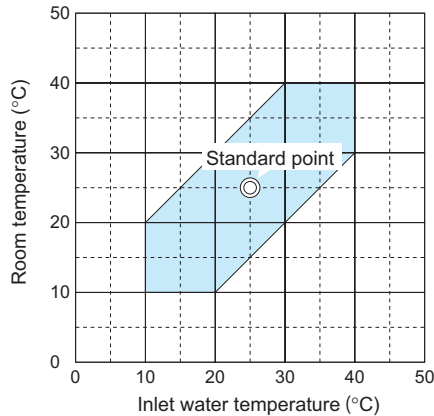

■ AKW569, 909

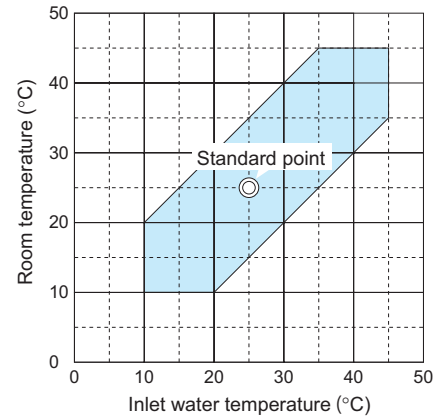

Water quality standard * Use water that satisfies the following standard for tap water level.

■ Guideline of Water Quality for Refrigeration and Air Conditioning Equipment (JRA GL02E-1994)

	Item	Chemical formula	Water quality standard	Unit
Standard items	pH	-	6.5 to 8.2	pH (25°C)
	Electrical conductivity	-	0.2 to 30	ms/m (25°C)
	Chloride ion	Cl ⁻	50 maximum	mg/L (ppm)
	Sulfate ion	SO ₄ ²⁻	50 maximum	mg/L (ppm)
	Acid consumption (pH4.8)	CaCO ₃	50 maximum	mg/L (ppm)
	Total hardness	-	70 maximum	mg/L (ppm)
	Calcium hardness	CaCO ₃	50 maximum	mg/L (ppm)
	Ionic silica	SiO ₂	30 maximum	mg/L (ppm)
Reference items	Iron	Fe	0.3 maximum	mg/L (ppm)
	Copper	Cu	0.1 maximum	mg/L (ppm)
	Sulfide ion	S ²⁻	Not to be detected	mg/L (ppm)
	Ammonium ion	NH ₄ ⁺	0.1 maximum	mg/L (ppm)
	Residual chlorine	Cl	0.3 maximum	mg/L (ppm)
	Free carbon dioxide	CO ₂	4.0 maximum	mg/L (ppm)
	Stability index	-	6.0 to 7.0	-

External dimension diagram

AKW149

With pump/tank

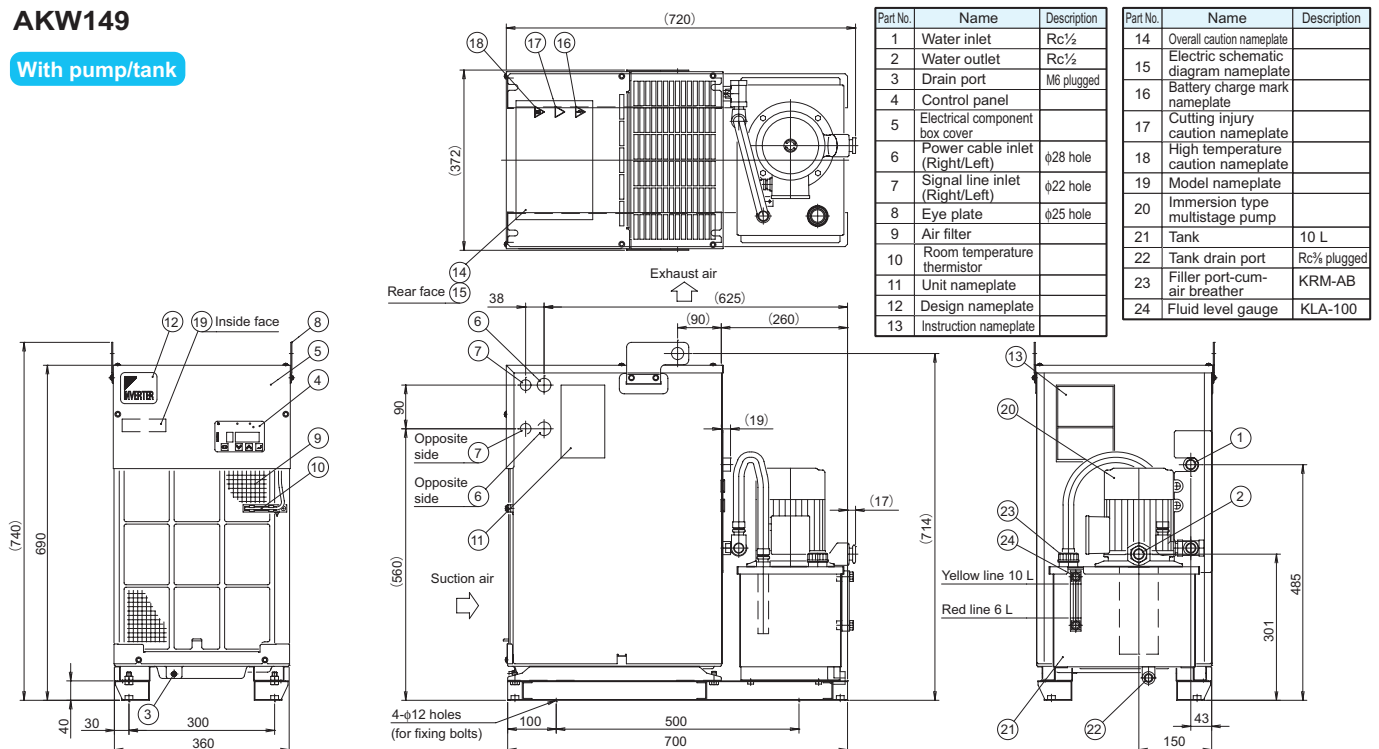

External dimension diagram

AKW329

With pump/tank

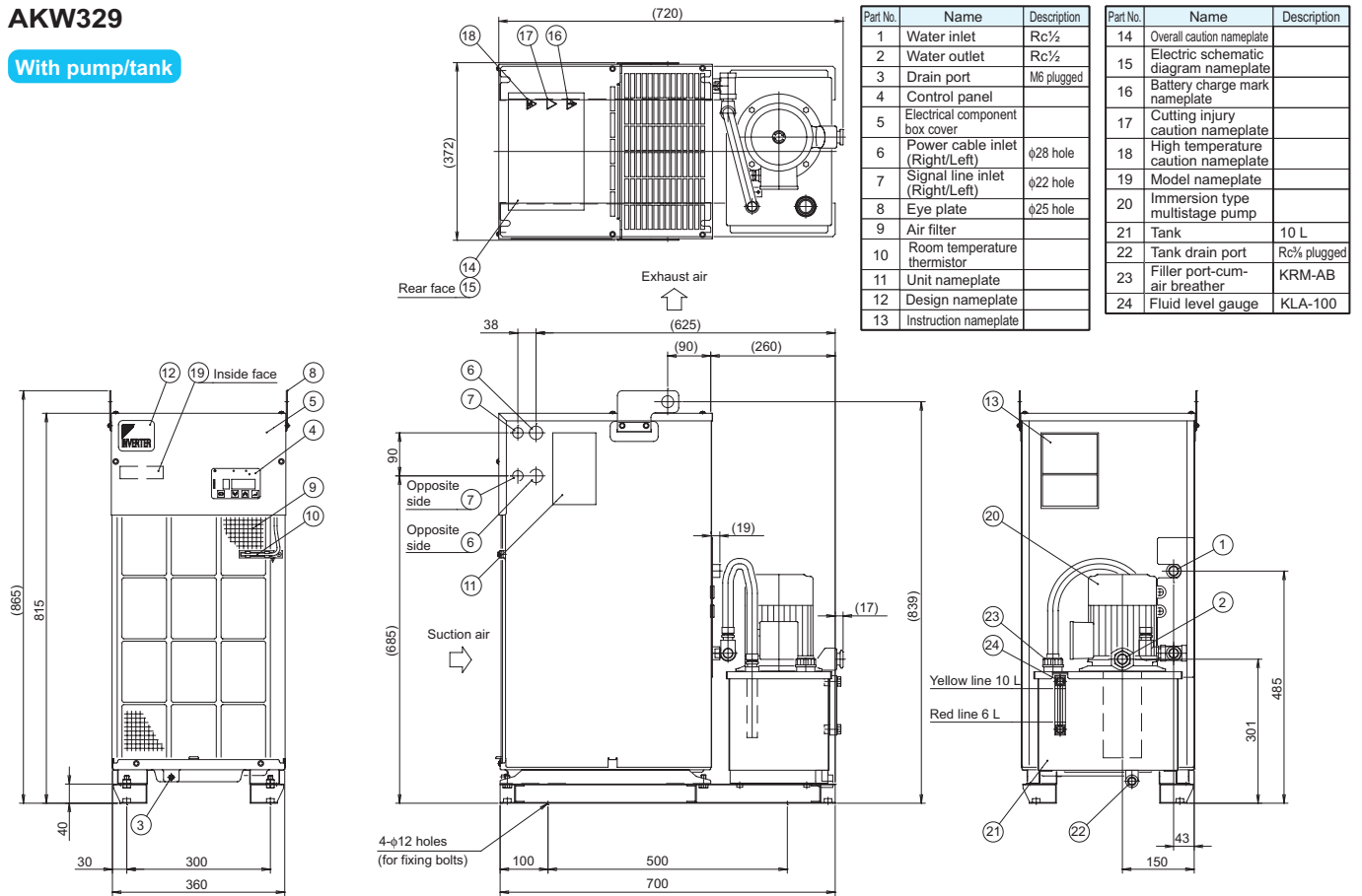

AKW439

With pump/tank

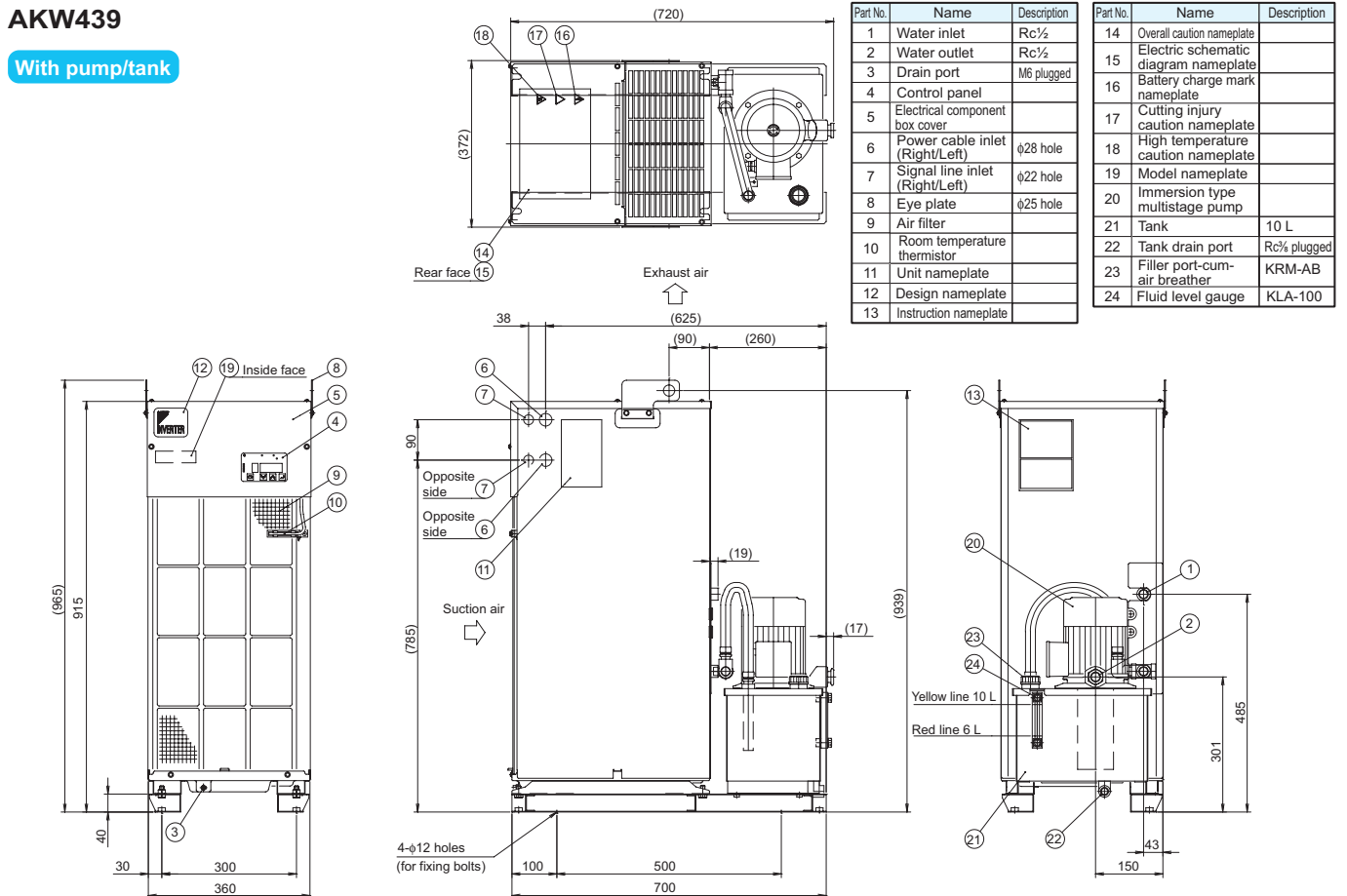

Refer to the individual product catalog for the external dimensions of the models without pump/motor covers or a pump/tank.

Contact Details

Before using the product, please check the guide pages at the front of this catalog.

Internet

<http://www.daikinpmc.com/en/>

For latest information, PDF catalogs and operation manuals

External dimension diagram

AKW569

With pump/tank

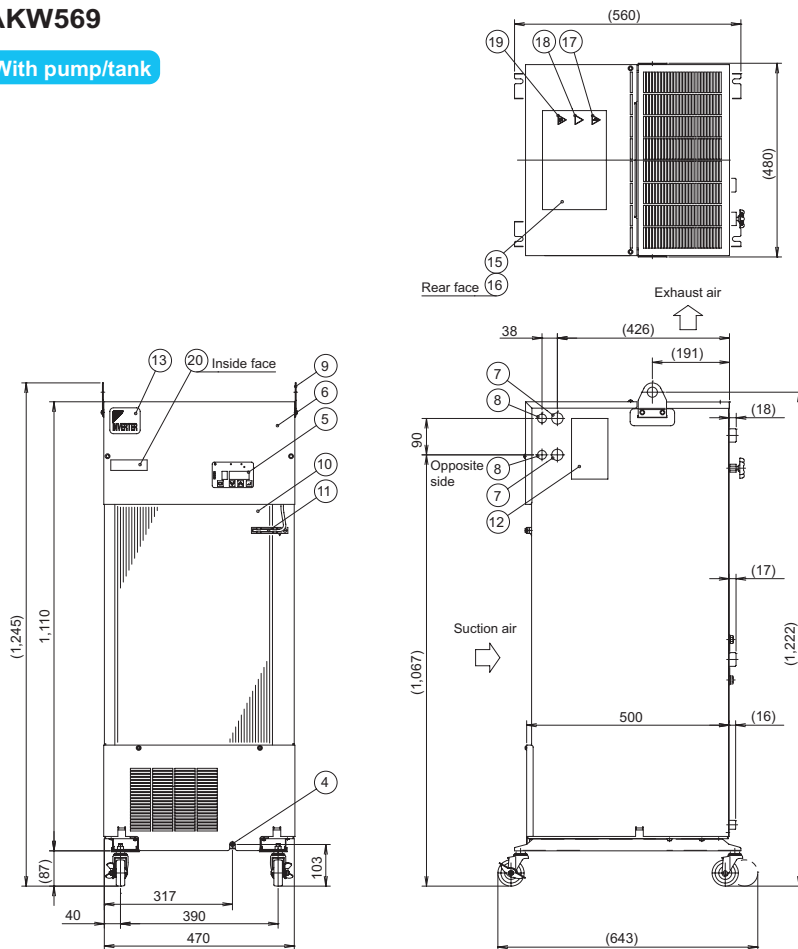

Part No.	Name	Description
1	Water inlet	Rc ³ / ₄
2	Water outlet	Rc ³ / ₄
3	Tank drain	Rc ¹ / ₂ plugged
4	Drain port	M6 plugged
5	Control panel	
6	Electrical component box cover	
7	Power cable inlet (Right/Left)	φ28 hole
8	Signal line inlet (Right/Left)	φ22 hole
9	Eye plate	φ25 hole
10	Air filter	
11	Room temperature thermistor	
12	Unit nameplate	

Part No.	Name	Description
13	Design nameplate	
14	Instruction nameplate	
15	Overall caution nameplate	
16	Electric schematic diagram nameplate	
17	Battery charge mark nameplate	
18	Cutting injury caution nameplate	
19	High temperature caution nameplate	
20	Model nameplate	
21	Fluid level gauge	KLA-100
22	Pressure gauge	
23	Glove valve	

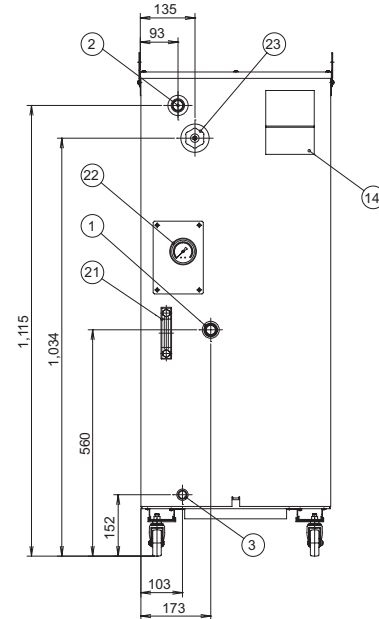

AKW909

With pump/tank

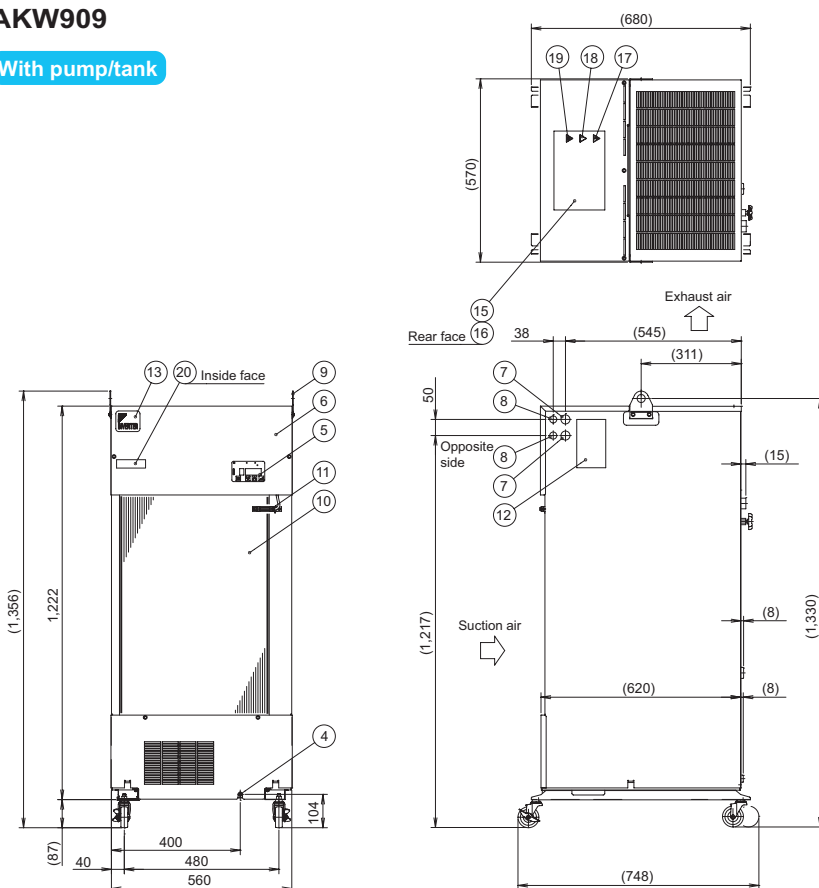

Part No.	Name	Description
1	Water inlet	Rc ³ / ₄
2	Water outlet	Rc ³ / ₄
3	Water drain	Rc ¹ / ₂ plugged
4	Oil pan drain	M6 plugged
5	Control panel	
6	Electrical component box cover	
7	Power cable inlet (Right/Left)	φ28 hole
8	Signal line inlet (Right/Left)	φ22 hole
9	Eye plate	φ25 hole
10	Air filter	
11	Room temperature thermistor	
12	Unit nameplate	

Part No.	Name	Description
13	Design nameplate	
14	Instruction nameplate	
15	Overall caution nameplate	
16	Electric schematic diagram nameplate	
17	Battery charge mark nameplate	
18	Cutting injury caution nameplate	
19	High temperature caution nameplate	
20	Model nameplate	
21	Fluid level gauge	KLA-100
22	Pressure gauge	
23	Glove valve	

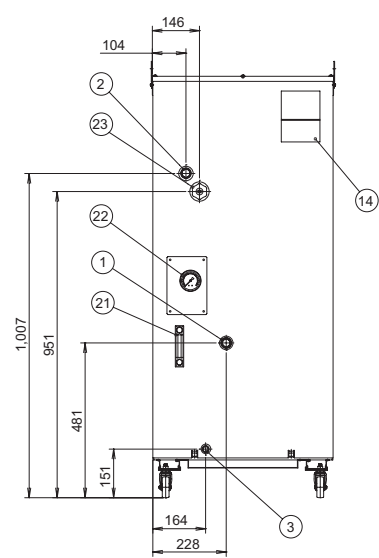

Cooling capacity characteristic chart

AKW149

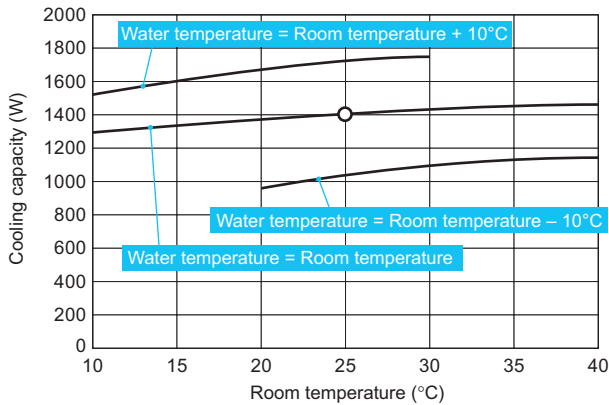

AKW189

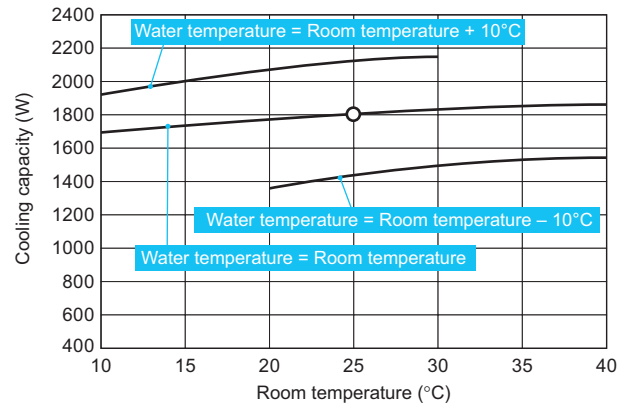

AKW329

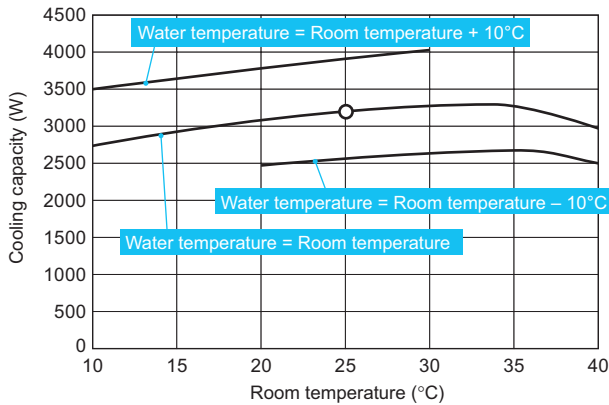

AKW359

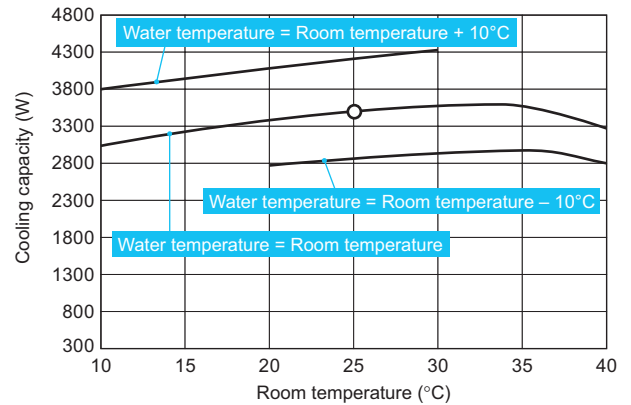

AKW439

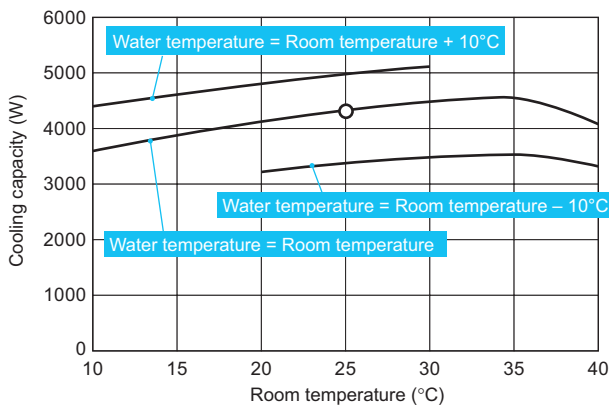

AKW459

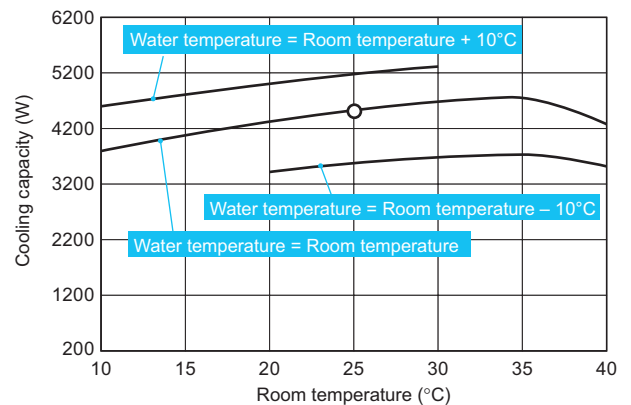

AKW569

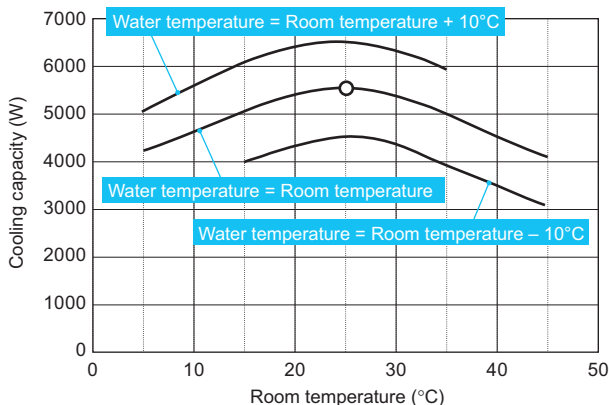

AKW909

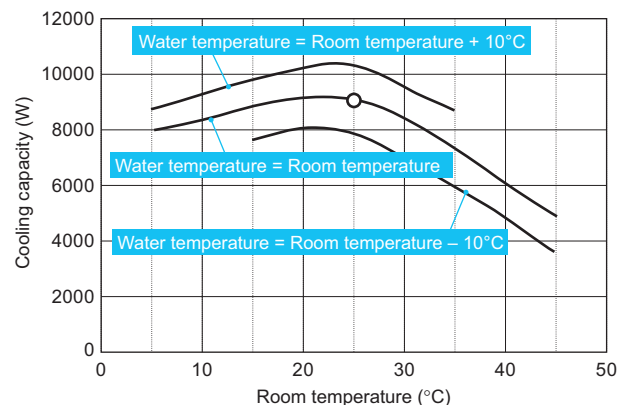

The mark "○" shows the standard point. (Room temperature: 25°C, water temperature: 25°C)

OIL COOLING EQUIPMENT

Contact Details

Before using the product, please check the guide pages at the front of this catalog.

Internet

<http://www.daikinpmc.com/en/>

For latest information, PDF catalogs and operation manuals

Pump flow rate characteristics

The following diagrams show the flow characteristics of the pumps with the internal pressure loss taken into account.

Select the diameters and lengths of pipe by referring to the following diagrams to keep the circulating water volume maintained within the permissible range.

AKW149

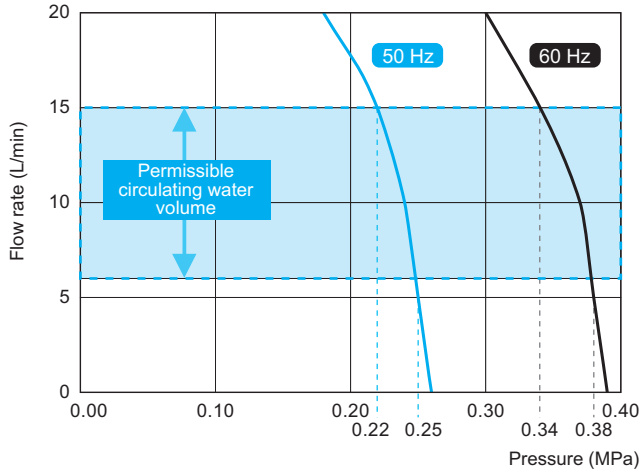

AKW329

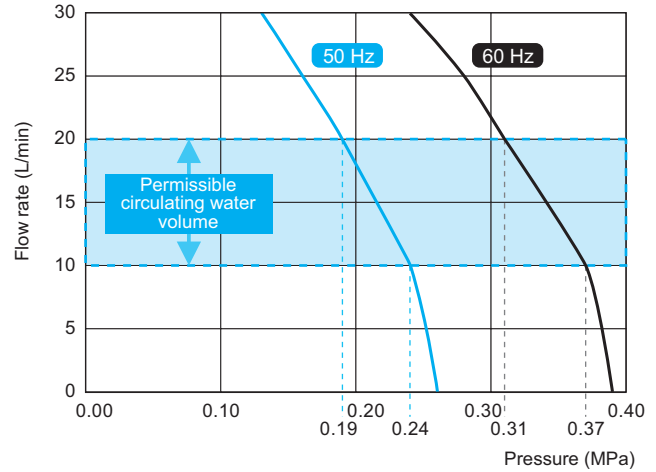

AKW439

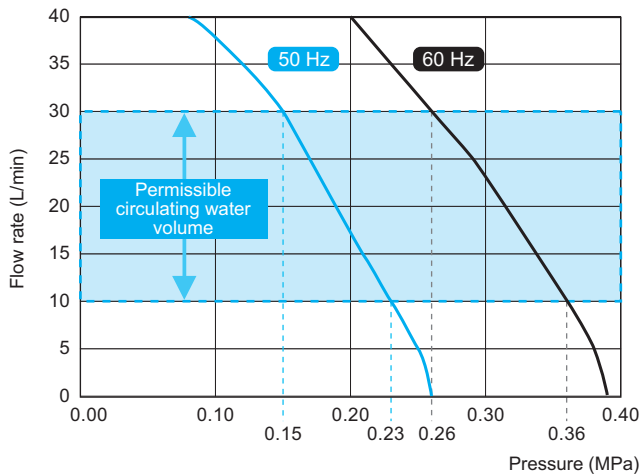

AKW569

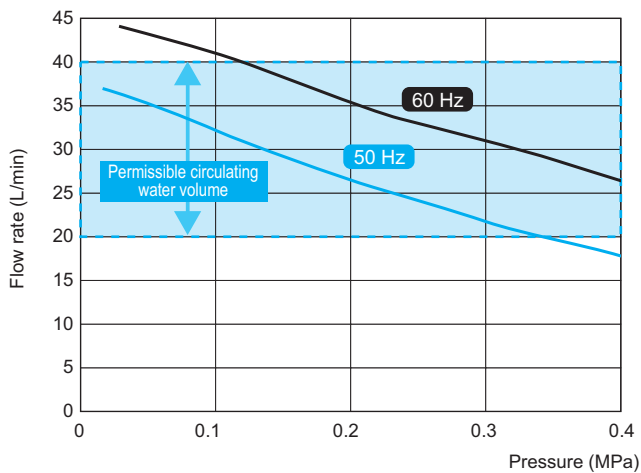

AKW909

